

Compound Bow User's Guide

Thank you for purchasing this bow. Your bow was manufactured from the finest materials available and handcrafted. With proper care and use you will enjoy this product for years to come. We wish you much success in the archery field you have chosen to pursue. Please read this entire booklet before shooting or adjusting your bow. Remember, most adjustments to a compound bow should be made on a bowpress. Whenever shooting a bow, be certain of your target as well as what else lies downrange.

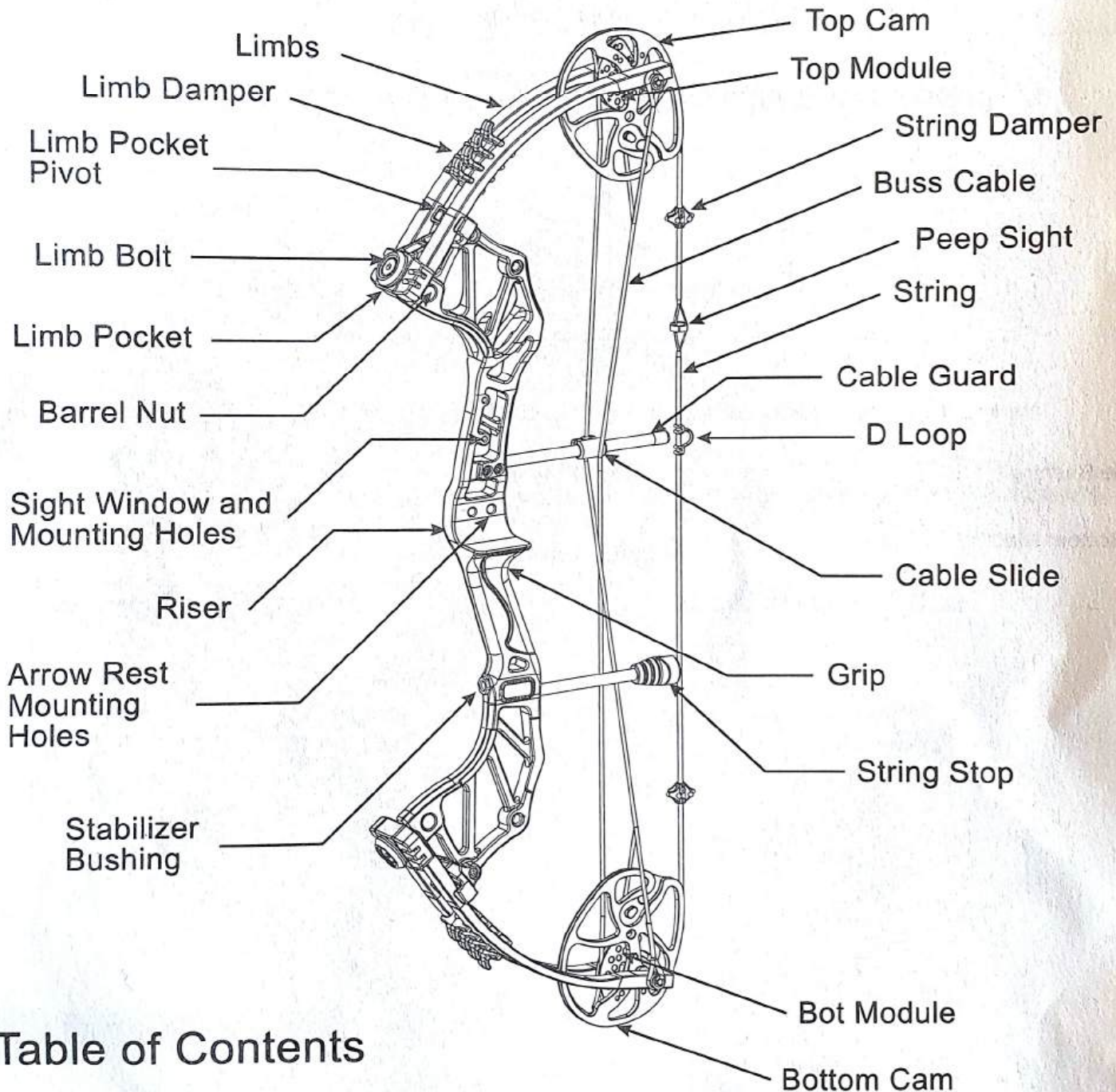
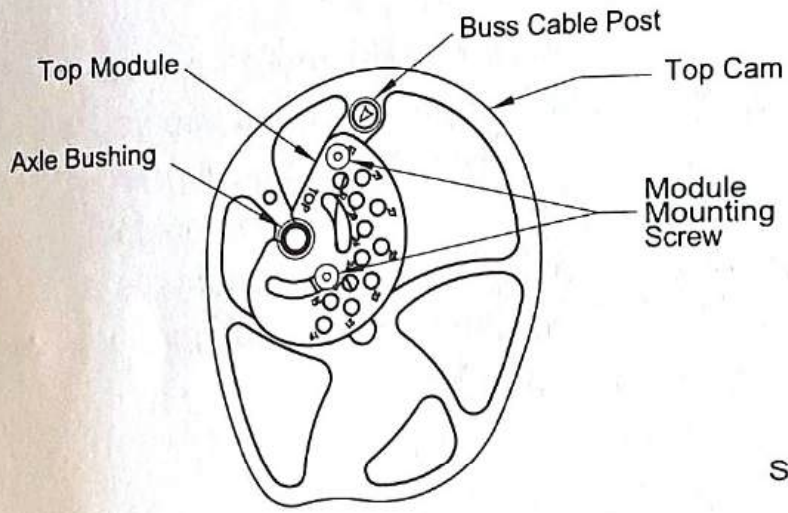
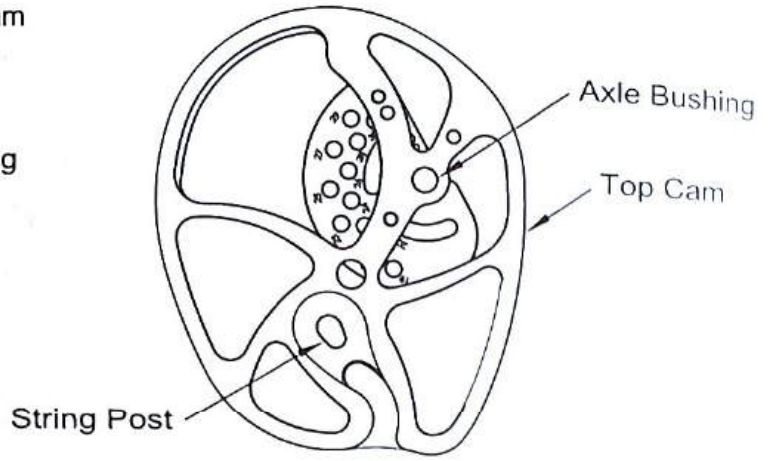

Table of Contents

- I. General Operating Instructions
- II. Bow Maintenance
- III. Safety
- IV. Setting-Up Your Bow



TOP CAM FRONT SIDE



TOP CAM BACK SIDE

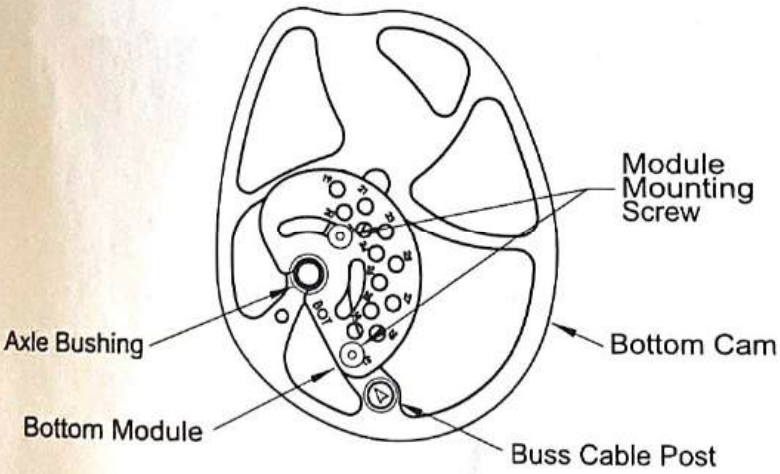

BOTTOM CAM FRONT SIDE

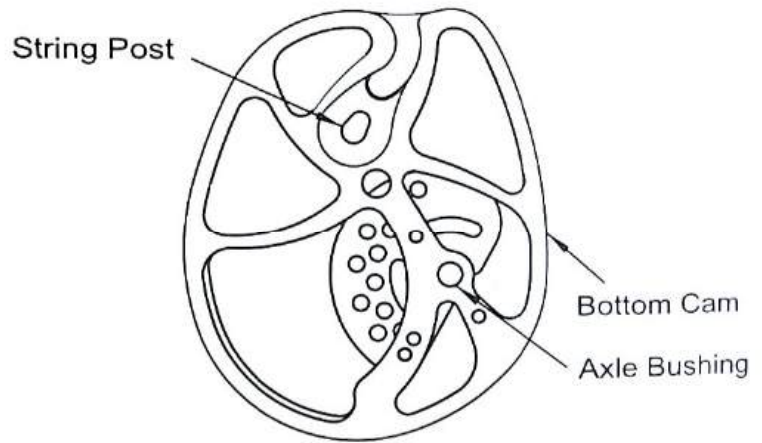

BOTTOM CAM BACK SIDE

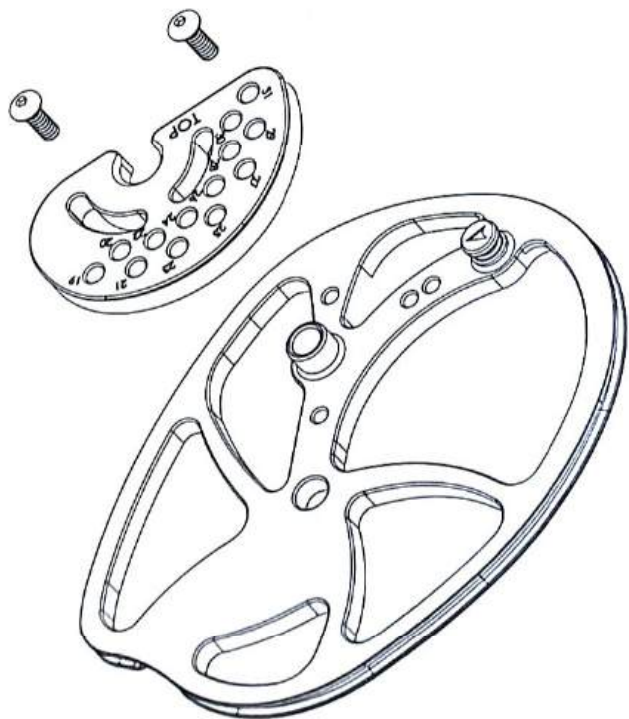

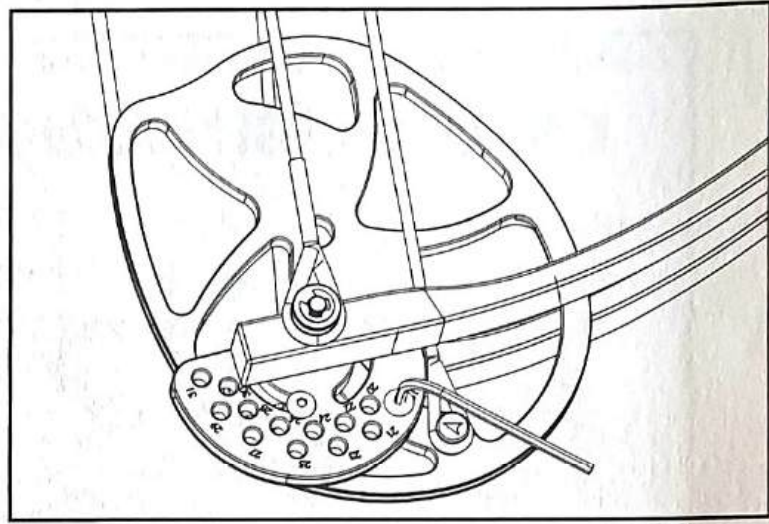
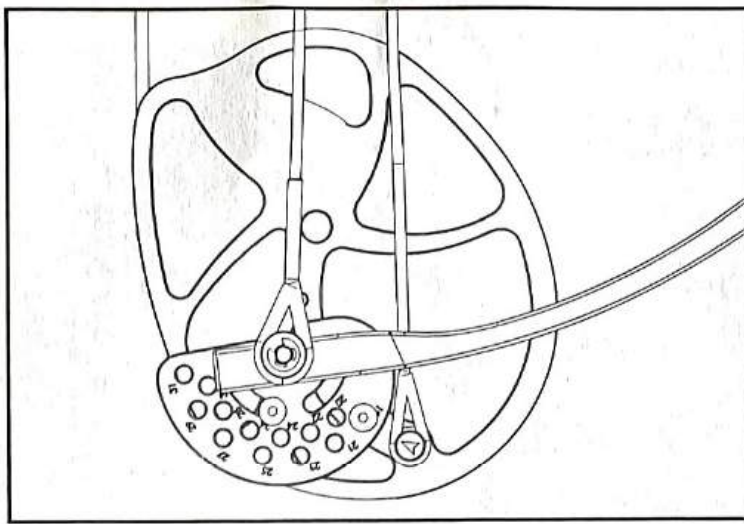

This bow is designed to have 13 different draw lengths (19"~31"). The higher number, the higher the draw length.

Draw length adjustment

To increase the draw length, use a module with a higher number.

Using an allen key to loosen the screw in cam until the module is free.

Then place screw in the desired draw length hole and tighten the screw.

Do not over tighten screw.

Make sure the module is flush against the face of the cam while tightening the screws.

Next perform the same operation on the opposite cam.

Be sure that both the top and bottom cams are using the same draw length modules.

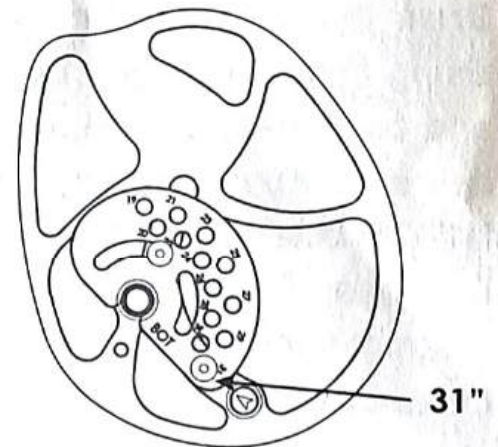
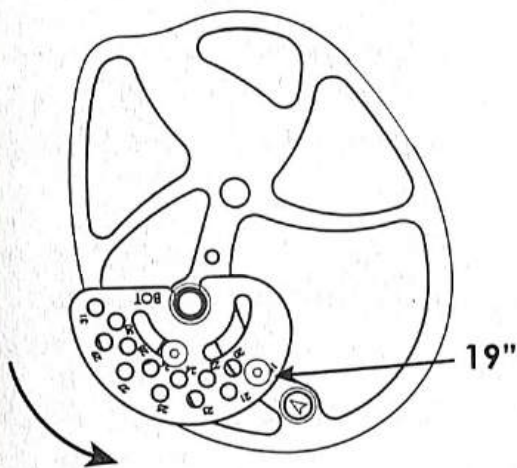

MAX LEF OFF: 70-75%



DRAW WEIGHT ADJUSTMENT

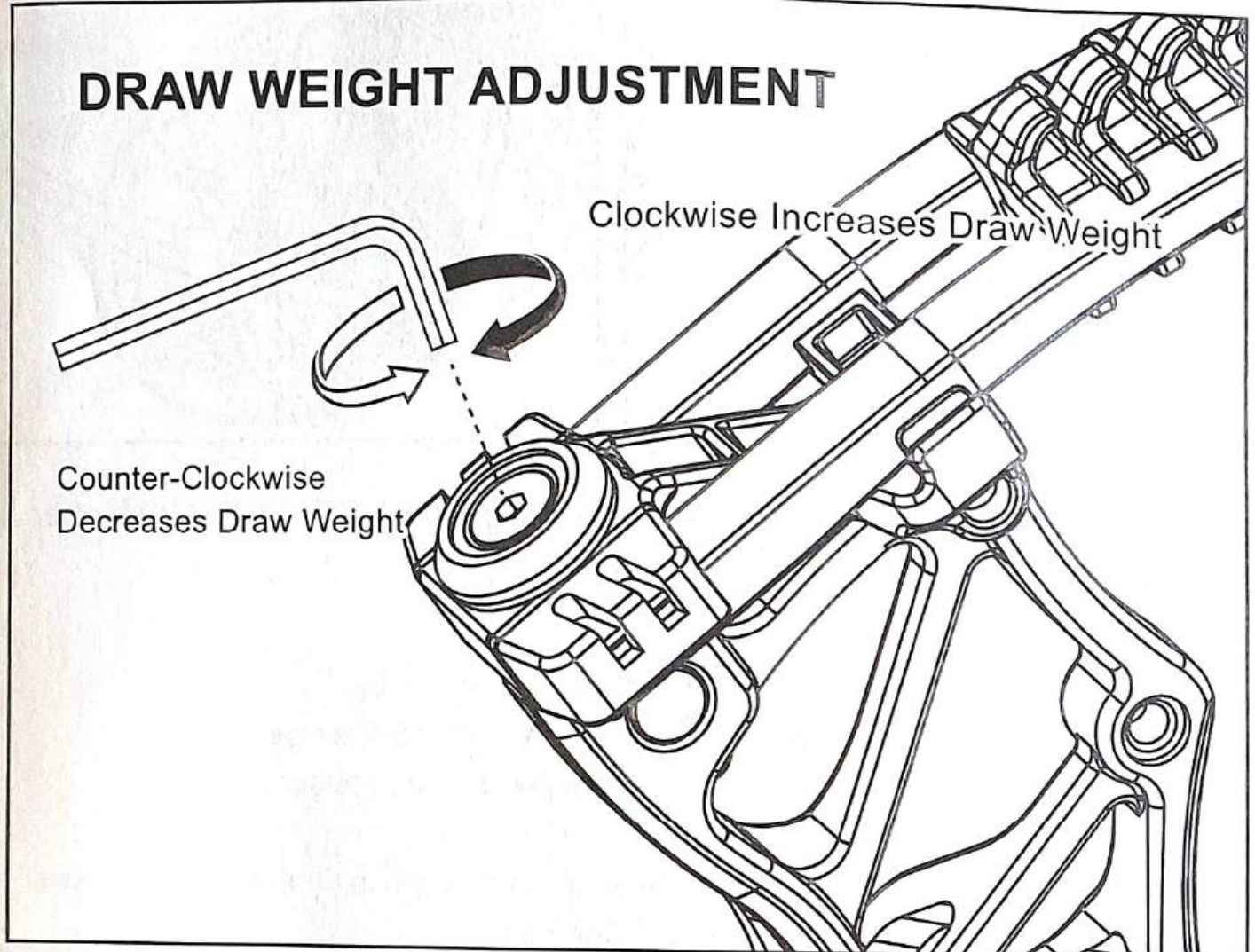

Draw Weight Adjustment

Using an allen key, turn the limb bolts clockwise to increase draw weight and counter-clockwise to reduce draw weight. Bow weight will increase or decrease approximately 5 pounds per turn.

IMPORTANT: Both limb bolts must be adjusted equally.

Likewise, do not turn one limb bolt more than two turns ahead of the other when making adjustments.

Limb bolts must never be backed out more than 4 full turns.

I. General Operating Instructions

- Always inspect your bow thoroughly before each shooting session to insure that it is in good working order. Check for worn or missing components and have them replaced as required.
- Inspect your arrows to insure that they are straight and that each nock is in good condition. A cracked nock can break when fired from the bow and cause the bow to "dry fire" which can cause injury to the archer and damage to the bow.
- When purchasing arrows for your bow, consult the selection chart from the arrow manufacturer and select the correct arrow for your application. Always use an arrow that meets the weight requirement marked on the specification label on the lower limb of your bow. Failure to do so could cause personal injury and damage to your bow.

II. Bow Maintenance

Your bow will give you many years of service if maintained and cared for properly.

- Keep synthetic cables and string waxed. Apply bowstring wax to your synthetic cables and string before each shooting session.
- Strings and cables must be replaced periodically. A worn cable or string can suddenly break causing serious injury to the archer and damage to the bow. It is recommended that the string and cables be replaced every 5,000 shots or 12 months.
- Always store your bow in a cool dry place. High temperatures, such as those that can occur in a truck or interior of a vehicle, can cause serious damage to your bow.

III. Safety

As with any weapon, safe operation of your bow must always be the highest priority. **ALWAYS WEAR SAFETY GLASSES WHEN HANDLING A BOW.**

Do not attempt to use your bow without proper instruction. Doing so can result in serious injury.

- a) Never "dry-fire" any bow. Dry-fire is to draw and release the bowstring without an arrow in the bow. Dry-firing will likely cause damage to the bow and serious injury to the archer.
- b) Always be sure of your intended target as well as what lies behind the target area. An arrow can travel a considerable distance, so it is important to have a safe and sound backstop.
- c) If you draw a bow and need to let it down, do so in a slow and careful manner. Keep your support arm straight and prepare for a rapid and violent

let-down. Avoid hitting your hand on protruding accessories such as the cable guard or quiver. Keep your head and face back and out of danger during let-down. Never draw a bow with a peak weight above your comfort level. Always use a bow sling when drawing a bow.

d) Never modify any part of the bow or its components by drilling extra holes or removing material. This voids the warranty and presents safety problems.

IV. Setting-Up Your Bow

Nocking Point Placement:

Finger shooters: For the initial setting, install the nocking point on the bowstring approximately $5/16$ " plus the arrow width above a point where a horizontal line from the rest intersects the string.

Release Aid shooters: Install the nocking point the width of the arrow above a point where a horizontal line from the rest intersects the string. When the arrow is in position on the rest, the arrownock should fit snug against the bottom of the nocking point.

Arrowrest Adjustment:

The in/out position of the arrowrest should be adjusted so that the arrow is in alignment with the string when shooting with a release aid.

The arrow tip should be $1/2$ shaft diameter to a full shaft diameter to the left on a right-handed bow, (opposite for left-handed) when shooting with fingers.

Sight Adjustment:

When adjusting the sight pin locations, always remember to "follow the group". That is, if the shot group is to the left of the target, move the sight pins to the left. If the shot group is low, move the sight pins down.

Cable Guard Adjustment:

The purpose of a cable guard is to hold the cables out of the path of the arrow. When adjusting the angle of the cable guard, adjust it so the cables just clear the arrow vanes. On one-cam bows using an offset cable guard rod, adjustments to the cable guard must be done with the rod in the up position (approximately 1 o'clock). Excessive arrow clearance may cause the cables to track incorrectly on the wheels and cause serious personal injury and/or damage to the bow.